



# COBBITTY

by mirvac

## DESIGN GUIDELINES

---

---

JULY 2023 | REVISION 6



# CONTENTS

---

---

JULY 2023  
REVISION 6

Cobbitty by Mirvac	4
1. Cobbitty By Mirvac - The Vision	6
2. The Purpose of the Design Guidelines	8
3. Approval Process	10
4. Façade Design & Articulation	12
4A. Façade Design Materials & Finishes	14
4B. Garages & Driveways	16
4C. Designing on a corner	17
4D. Façade Replication	18
5. Colours	19
6. Front Doors	21
7. External Lighting	22
8. Roofs and Eaves	23
9. Fencing	24
10. Landscaping	25
11. Letterboxes	26
12. General Items - Street Amenity & Privacy	27
13. Sustainability	28
Appendix A - Design Review Panel Application Checklist	30
Appendix B - Design Assessment Application Form	31
Appendix C - Neighbourhood Plan	32



# COBBITTY BY MIRVAC

---

A little bit country. A little bit city. A lot like the home you always dreamed of.

## FOR THE CHAMPIONS OF THE GOOD LIFE

---

A new community within a town steeped in history, beckoning you to that happy place that sits within all of us. Home.





# 1. THE VISION

Cobbitty by Mirvac is a rare opportunity to live happily between two worlds. A pocket of peace and tranquility whose rural town character is cherished and protected, yet connected to Camden and Narellan, among the fastest growing localities in Australia.

To ensure homes are sympathetic to the beautiful rural landscape and heritage of Cobbitty, every resident can be assured of a harmonious built environment that enhances and protects the value of your home.

The amenity and public spaces at Cobbitty by Mirvac have been meticulously planned to create a unique place that reflects the character of the existing Cobbitty town.

## THE COBBITTY BY MIRVAC VISION

This book has been made to assist you in understanding and interpreting the Design Guidelines and provide you with some inspiration and ideas on how to achieve the Cobbitty by Mirvac vision.

At Mirvac, our vision is to set the standard as a world-class Australian property group, harnessing the talent of our people to re-imagine urban life wherever we manage, develop and build. We don't just seek to re-build or renovate. We strive to completely re-think how places are defined and identify opportunities to benefit our customers and communities as part of this process.



Artist's impressions as at 27.10.22. Produced prior to all planning approvals being in place and prior to commencement of development, and is therefore subject to change. The information, images and artist's impression depicting landscaping, threshold, footpaths, amenity etc are intended only as a guide and are not to be relied on as a representative of the final product.



## 2. PURPOSE OF THE DESIGN GUIDELINES

These Design Guidelines provide essential information on the objectives, guidance and controls that have been implemented to achieve Cobbitty by Mirvac's vision.

The Cobbitty by Mirvac Design Guidelines have been established to provide further guidance and compliment the site related Oran Park Precinct Development Control Plan.

Compliance with all relevant planning controls and these Design Guidelines is required to ensure development approval is achieved.

Design Guidelines are broken down into easy to understand sections. Each section explains how to approach design of key elements of your home and controls that the Design Review Panel (DRP) will need to see when approving your home design. The DRP 'may' provide constructive feedback to assist you and your builder in addressing these controls.

### SO WHAT ARE DESIGN GUIDELINES, AND WHY HAVE THEM?

Design Guidelines are a set of principles used to inform the outcome of your home. Each individual home should contribute to the surrounding environment and streetscape in a positive way.

The aim of the Design Guidelines is to create a coherent vision for your story to unfold. The guidelines ensure all homes within the Cobbitty by Mirvac community are built to a high standard and encourage various housing styles sympathetic to the local streetscape and neighbourhood. The Design Guidelines will assist in providing you with peace of mind and protection for your investment.

\*Artist's impressions as at 21.10.22. Produced prior to all planning approvals being in place and prior to commencement of development, and is therefore subject to change.

The information, images and artist's impression depicting landscaping and other amenity are intended only as a guide and are not to be relied on as a representative of the final product.





# 3. THE APPROVAL PROCESS

A Design Review Panel (DRP) has been established to review and approve all new dwellings and associated landscaping, subject to compliance with these Design Guidelines.

To enable the DRP to make a determination, the documents included within the DRP Application Checklist (See Appendix A) must be submitted for approval prior to lodgement of a Development Application and Construction Certificate Application with Council or an Accredited Building Certifier.

Set out step by step below is the process for buying your land, achieving development approval and constructing your new home at Cobbitty by Mirvac.

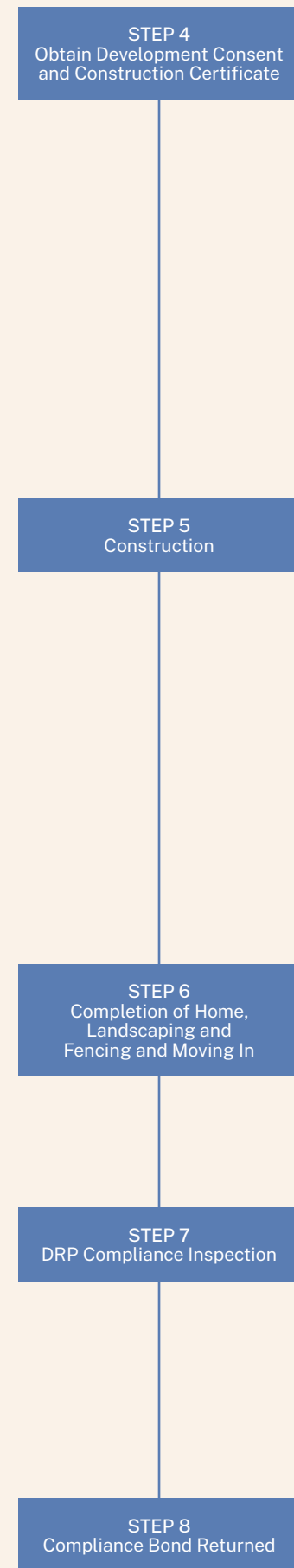
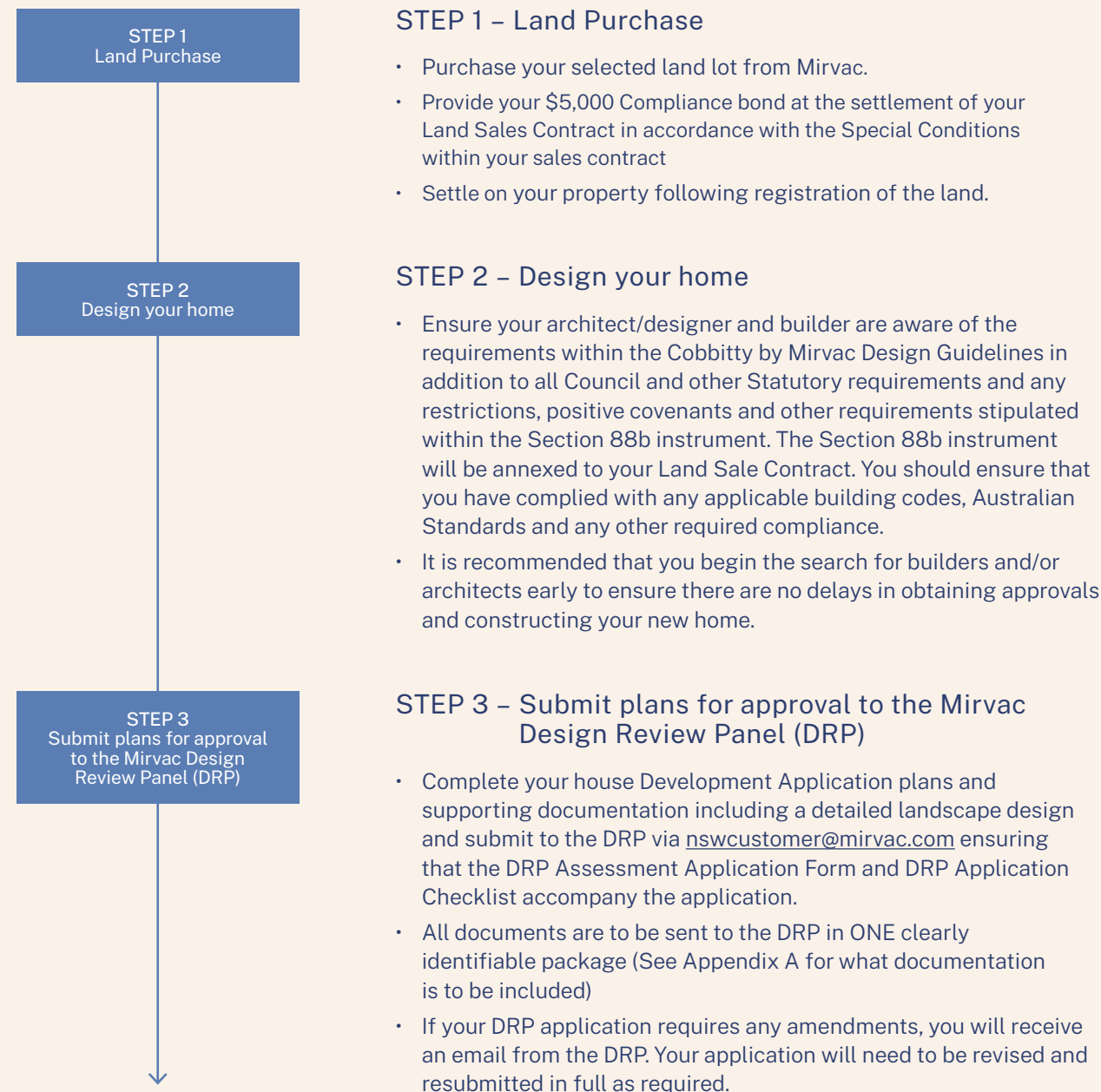

## STEP 4 – Obtain Development Consent and Construction Certificate

- As part of your Development Application, you will be required to submit your DRP approved plans to Camden Council or Accredited Building Certifier. Camden Council or Accredited Building Certifier will assess your application and issue your development consent.
- Prior to commencing construction, a Construction Certificate is also required. Your Construction Certificate application can either be lodged with Camden Council concurrently with or following your Development Application or Accredited Building Certifier.
- If any amendments are made to your application, you will be required to resubmit your application to the Mirvac DRP for reassessment and approval.

## STEP 5 – Construction

- When Camden Council or Accredited Building Certifier has issued the Construction Certificate and you have settled on your land, you are ready to start construction.
- In accordance with your Land Sale Contract, construction of your home must commence within 12 months of settling on your land and must be completed within 12 months of construction commencement.
- In accordance with your Land Sale Contract, your land lot is to be well maintained, free from rubbish and debris from the time of your settlement and throughout construction.
- It is recommended that you refer to these Design Guidelines regularly to ensure all requirements are met.

## STEP 6 – Completion of Home, Landscaping and Fencing and Moving In

- Your home, landscaping and fencing construction by your selected builder is completed in accordance with your DRP approved plans. From here construction is complete and you are able to move in and enjoy your new home.

## STEP 7 – DRP Compliance Inspection

- Once your home landscaping, driveway and fencing is completed in accordance with your approved plans, contact the DRP via [nswcustomer@mirvac.com](mailto:nswcustomer@mirvac.com) to arrange a compliance inspection.
- If further works are required following your compliance inspection, you will receive an email from the DRP notifying you of the works required.

## STEP 8 – Compliance Bond Returned

- Once the DRP has inspected your completed home and any additional works required (where applicable), your compliance bond will be returned.
- From here construction is complete and you are able to move-in and enjoy your new home

## 4. FAÇADE DESIGN

Creating a sense of entry to your home is crucial in creating a well-articulated and welcoming facade. When designing a facade, it is important not to over-complicate it. Instead, focus on drawing the eye to one main focal point. First and foremost, this should be your entryway. The most effective way to achieve this is orienting your home towards the primary street frontage (i.e., the street in which your address is) with well-defined design elements such as porches, verandas and balconies that protrude outwards.

### CONTROLS

- Front entries should be located on the street facing façade of the house. For corner lots, the shorter street frontage shall be the primary frontage (unless otherwise approved by the DRP).
- The front entry of your home must be clearly visible from the street.
- All homes are to include windows facing the primary street frontage. They should be appropriately articulated as elements of the façade design.
- A minimum 450mm eave is preferred unless otherwise approved by the DRP, except for lots with zero lot lines\*.
- Continuation of materials used on the front of your home must return to the side of the homes to a length of four (4) metres, except for garages built on boundary.

\*Applicable only to lots within area noted as Neighbourhood 1 in Neighbourhood Plan located in Appendix C.



Artist's impression

### What is a Zero Lot Line?

A zero lot line refers to a home being built up to or very near the edge of the nominated side boundary line of a lot. A zero lot line is nominated on an allotment in the subdivision plan via an Easement for Access and Maintenance and normally will have a lot width 12.5m or less.

### DESIGN TIP What is a facade?

A Facade refers to the exterior of your home in which typically faces the street. It will incorporate design elements, including doors, windows, and entryways.



## 4A. FAÇADE, MATERIALS & FINISHES

### CREATING A MATERIAL PALETTE

Your selected material palette will form the basis of how the exterior of your home will look and feel. That's why it is essential to carefully consider the materials that will make up your facade, to capture both your style and the unique character of Cobbitty by Mirvac. After all, it's the first thing that people see on the approach to your property.

### CONTROLS

- Upper storeys of double storey homes must be constructed using lightweight materials (such as weatherboard) or rendered brick. Alternative materials are subject to the approval of the Design Review Panel\*.
- Brickwork on the ground storey may be rendered and painted. In instances where the brickwork is not rendered or painted, brick colours are permitted as per figure 1.
- Security blinds or shutters are not permitted to windows and doors which are visible from the street.
- A maximum of 50% of the front façade can consist of brick with reference to the previous points on permitted colours and forms.
- Multi-coloured bricks or multi-coloured roof tiles are not permitted.

- When incorporating timber elements to the facade, it is recommended that these elements are included in areas of the facade which would enable easy maintenance.
- Unfinished materials including block work, highly reflective or unpainted plain materials are not permitted. All external surfaces are to be in a finished state (painted or coated) prior to the occupation of your home.
- Fibrous Cement (FC) sheeting with battens is not permitted.
- Any ornamentation must compliment the design of the home. No historical styles or details will be permitted (e.g. arches, fretwork, decorative columns, mouldings, animals ornaments, gargoyles, etc.)

\* Applicable only to lots within area noted as Neighbourhood 1 in Neighbourhood Plan located in Appendix C.

### COASTAL HAMPTONS



### LIFESTYLE

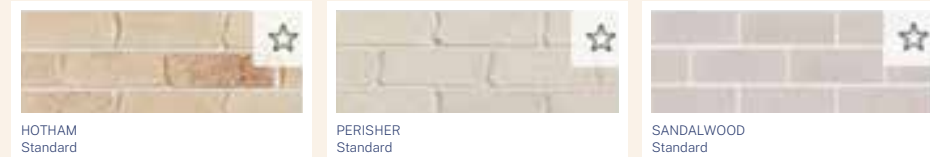

### HOME

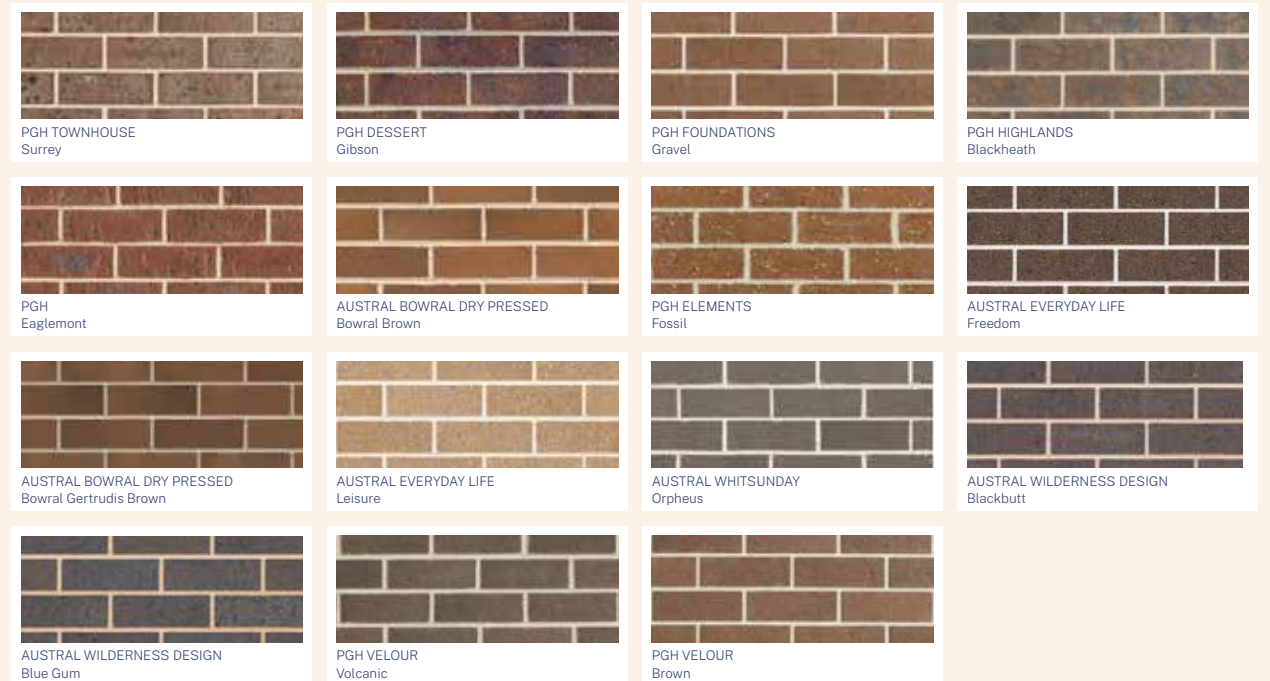

Figure 1 – Brick Colours



## 4B. GARAGES & DRIVEWAYS

---

Your driveway might not seem as important as other parts of your new home. Although, given that it takes up a significant amount of surface space in the overall facade of your home, careful planning will make a lot of difference to how your home will present.

---

### CONTROLS

- Driveways are to have soft landscaped areas on either side, suitable for water infiltration.
- Only one driveway is permitted per allotment.
- Driveways are to be of concrete (sealed/painted, exposed aggregate or raw concrete. Stencilled concrete is not permitted). Mid to light colours for the driveway are encouraged to reduce the effect of heat absorption and provide a cooler trafficable surface.
- Driveway and crossover must be complete prior to occupation of the home.
- Double garage doors should be a maximum of 6m wide.

- Colour of the garage door must complement the primary colour of the façade (subject to the approval of the Design Review Panel).
- Single storey homes on lot widths less than 10m are not permitted to have single garages. Single garages on these lot widths are only permitted on double storey homes.
- In Neighbourhood 1 Single storey homes on lot widths less than 12m are not permitted to have single garages. Single garages on these lot widths are only permitted on double storey homes
- Panel lift or panel glide doors are required. Roller doors are not permitted to front facades.
- Car ports are not permitted in front of the building line.

### GARAGES

As we have established, your home and, in particular, your entryway should be the main focal point. In turn, this means that garages should not dominate the façade or compete for attention. Ensure your garage does not contribute to more than 60% of your lot width so that it does not distract from your home.

#### DESIGN TIP A sense of arrival

---

*Once you build your home, it's time to think about what other visual cues you can add to create a sense of entry to your home. Think about how steps and pathways can be installed to lead the eye to the front entrance, as well as more stylistic elements that can be added, such as feature pot plants that can be cleverly placed to create a great first impression and sense of arrival.*

---

## 4C. DESIGNING ON A CORNER

---

Whilst corner lots can offer more yard space and more natural light, they are also an excellent opportunity for clever and creative design. Having two street frontages means a more extensive canvas space and more of your home on display. To address both frontages, speak to your builder about an appropriate corner treatment.

---

### SO WHAT IS A CORNER TREATMENT?

- A 'corner treatment' is a term used to describe the applied design elements to your secondary frontage.
- A corner treatment aims to create well-articulated elevations whilst minimising blank wall space. Addressing your secondary frontage can be achieved using verandas, pergolas, porches, pop-outs, differing setbacks, and the like.
- In the same way you can activate your secondary frontage, think about how any other elevations that may be facing public open space can be better utilised. For example, should your home back onto a reserve or park, consider how using design elements such as balconies and windows to create outlooks will help maximise your usable space whilst taking advantage of any potential views.
- Activating each side of your home that faces public view will help create an attractive visual composition and streetscape whilst helping build a more interconnected community.

### CONTROLS

- A habitable room window must be provided to the secondary street frontage of your home.
- Continuation of façade materials and articulation around the corner is to be consistent between primary and secondary street frontages.
- A home on a corner lot or adjoining public open space must be designed to address each of the front and side streets and any adjacent public open space.
- All treatments on a corner lot or adjoining public open space will be reviewed by the DRP and additional treatment may be required.
- Minimising areas of blank wall to the secondary street facade through additional articulation (setbacks) and roofing articulation.
- Fencing on corner lots is important to the overall finish of the home - refer to Part 9 of these Design Guidelines as to how to finish the fencing on Corner Lots.

#### DESIGN TIP Create contrast

---

*When building a double-storey home on a corner, ensure that the upper floor is in contrast material to the lower floor. In turn, this will make sure that each floor is well-articulated and visually more attractive.*

---



## 4D. FAÇADE REPLICATION

The selection of the materials and palettes which will form your facade provide an opportunity to make the design of your home unique from that of your neighbours. Having an element of variety in facades throughout the streetscapes of the estate will provide benefit to both you and the overall Cobbitty by Mirvac estate, which is why the below facade replication controls have been incorporated.

### CONTROLS

- A dwelling must not have the same façade design as another dwelling within three lots in both directions on the same side or opposite side of the street.
- In the event that more than one application of the same façade design has been submitted for lots within close proximity, approval will be given to the first complete application to be received. Applications will be assessed strictly in order of receipt.
- Requests can be made to the DRP to determine whether a similar style façade is proposed to be used within a street. Similar facades will only be allowed if the DRP is satisfied there is sufficient variance in the appearance, which may be achieved through variation of colours and materials.
- Ornamentation must be compliment the design of the home. No historical styles or details will be permitted (eg. arches, fretwork, decorative columns, mouldings, animal ornaments, gargoyles, etc).

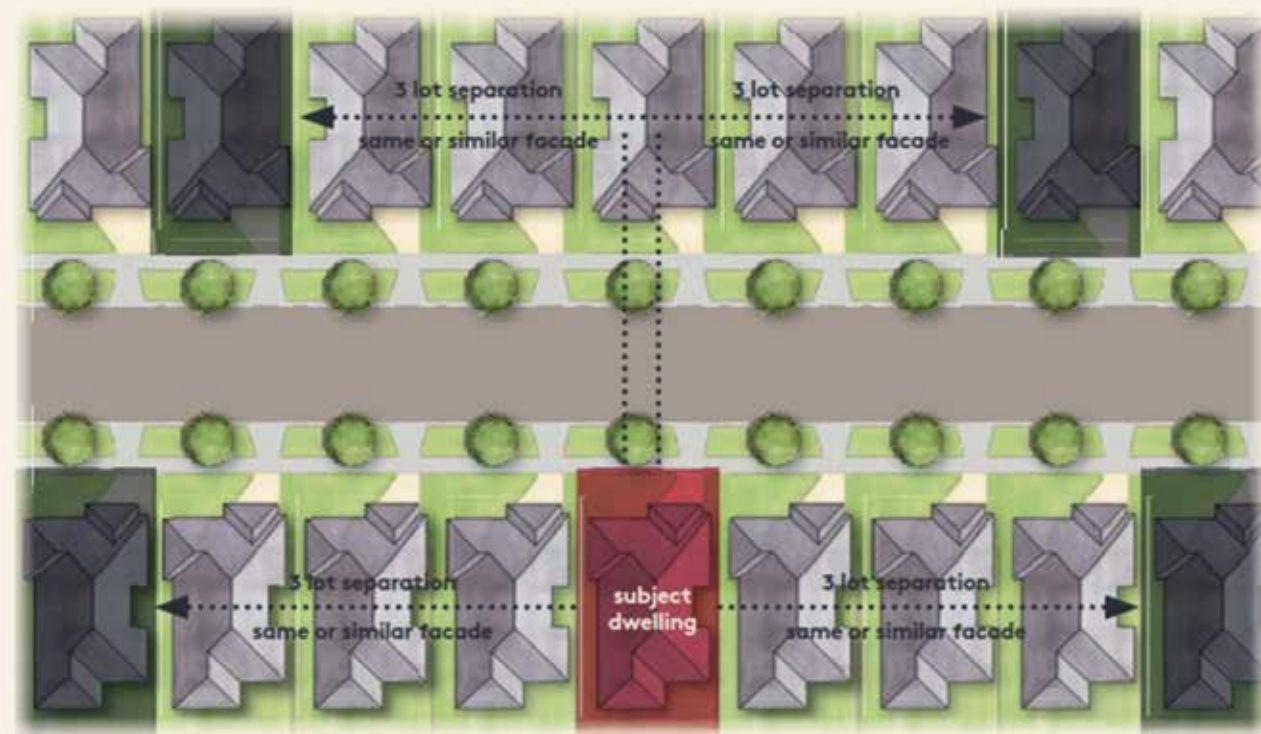

Figure 2 – Façade Replication Guide

## 5. COLOURS

### DESIGNING A COLOUR STORY

Whilst there are many elements that contribute to the overall look of your facade, including the roof covering, front entry door, garage door, landscaping and driveway – a great place to start is the colour palette! When choosing a colour palette for your home, subtlety tends to be more effective. The prominent colours of the facade should be light, muted and earthy, with deeper secondary and feature colours to articulate design elements and help create contrast.

### CONTROLS

- Building façade finishes and colours must complement the rural character of Cobbitty.
- Use of outlandish colours is not permitted (this will be subject to the approval of the Design Review Panel).
- Facades are generally to consist of no more than three colours, including a primary and secondary colour (subject to the approval for the Design Review Panel).
- Primary and secondary colours are interchangeable and if relevant must compliment the brick palette selected. Alternate colours will be considered by the DRP should they be complimentary

### SAMPLE PRIMARY COLOURS

 BLISSFUL WHITE SW1H1	 VIVID WHITE™ SW1G1	 FAIR BIANCA HALF SW1F1	 LEXICON® QUARTER SW1E1	 WHITE VERDICT QUARTER SW1D1	 WHITE POLAR HALF SW1C1
 WHITE CLOAK QUARTER SW1B1	 ICE QUEEN SW1A1	 ANTIQUE WHITE U.S.A.® SW1H7	 WHITE DUNE QUARTER SW1G7	 WHITE STARLIGHT HALF SW1F7	 OFF WHITE SW1E7
 SUMMER CLOUD QUARTER SW1H2	 LEXICON® HALF SW1G2	 WHITE POLAR QUARTER SW1F2	 WHITE ON WHITE™ SW1E2	 WHITE VERDICT HALF SW1D2	 WHISPER WHITE SW1C2
 WHITE DUNE HALF SW1B2	 WHITE CENTURY SW1A2	 RICE CROP SW1H8	 WHITE STARLIGHT QUARTER SW1G8	 WHITE SWAN SW1F8	 BERKSHIRE WHITE SW1E8
 SUMMER CLOUD HALF SW1H3	 SNOWY MOUNTAINS QUARTER SW1G3	 SNOWY MOUNTAINS HALF SW1F3	 LEXICON® SW1E3	 WHITE EXCHANGE QUARTER SW1D3	 WHITE CLOAK HALF SW1C3
 WHITE VERDICT SW1B3	 CHARTER WHITE SW1A3	 SWEDISH MOON SW1H9	 WHITE OPAL SW1G9	 LILIUM TWO SW1F9	 STOWE WHITE SW1E9



# 6. FRONT DOORS

## SAMPLE SECONDARY COLOURS



## SAMPLE ACCENT/TRIM COLOURS



## CHOOSING YOUR ENTRYWAY

Being the main point of entry into your home, the front door you select will draw the attention of visitors and bypasses. Your front door should complement your facade in style to enhance it instead of competing with it. Given that your entryway is the home's focal point, it is essential to consider how your front door contributes to your overall facade design.

## CONTROLS

- Front doors and security doors must compliment the facade design of the home with colours complimenting window frames.
- Front Doors must compliment the design of the home. No historical styles or details will be permitted (e.g. arches, fretwork, decorative columns).

## Example of Front Doors & Security Screens that are supported:



## Examples of Front Doors & Security Screens that are not supported:





## 7. EXTERNAL LIGHTING

### LIGHTING UP YOUR FACADE

Spending time to plan your outdoor lighting is time well spent, as a well thought-out lighting design is essential to adding street appeal to your home.

When done right, outdoor lighting can highlight architectural elements, showcase landscaping, and create an appealing and welcoming space for passers by and guests alike.

#### DESIGN TIP The right scale

*When choosing outdoor light fittings for your porch, consider the scale of your entryway. Choosing light fittings that are too large in scale can look overly dominant, whilst selecting a design that appears too small may not achieve the desired look.*

## 8. ROOFS & EAVES

### ROOF COVERINGS

Due to the large surface area, visually your roof contributes significantly to the overall look of your home. A roof's primary goal is to protect and weatherproof the house; however, it is essential not to underestimate the impact roofing can have on the style and appearance of the facade. Ultimately, choosing the roof covering for your new home should come down to several considerations. The roofing material should not only look great, but it should also last a long time. It should also aim to reduce your heating and cooling costs, and shouldn't require too much maintenance.

- Well designed hipped roofs and gabled elements which compliment the facade are supported by the Design Review Panel.
- Where roofs are pitched (not skillion or parapet/flat roofs) the roof pitch is to be a minimum of 22.5 degrees and a maximum of 30 degrees.
- No skillion or parapet/flat roof designs are allowed in Neighbourhood 1 unless they are not the dominant feature and compliment the overall facade design
- Roofs of lighter tones in colour are encouraged where possible.
- Roof coverings must be finished in one of the following materials:
  - Corrugated steel roof sheet (Colorbond)
  - Non reflective corrugated metal roof sheeting such as Colorbond
  - Low-profile concrete tiles
- Where eaves are provided on a house they are required to extend forward over garage doors.
- Eaves are not required to areas of facade finished to a parapet.
- No eaves are required along the side of the garage if the garage is built 0-200mm off the side boundary (i.e. a zero lot where accompanied by an easement for access and maintenance).

### EAVES

Eaves are the underside of your roof. Eaves may be installed on all sides of your home that face the street or public view, including all sides of your home where permitted.

#### SO WHY HAVE EAVES?

Eaves can substantially benefit the aesthetics and feel of the home. The overhang created by your eaves will direct water away from the walls and windows during the rain, which means less cleaning and greater longevity in your build. Eaves can also assist in reducing your cooling bills in the summer by acting as a shade barrier between the high sun and your windows.

Unless otherwise approved by the DRP, in Neighbourhood 1 eaves (minimum 450mm) are preferred to all front and sides of the home that face a street or public open space, except for zero lot lines.

#### DESIGN TIP Let there be light

*Your eaves can be utilised to house external recessed lights such as down-lights. Installing recessed outdoor lighting to your eaves will significantly enhance the exterior of your home when strategically placed to highlight architectural features.*



# 9. FENCING

Fencing is a major element in the overall character of the streetscape. A degree of consistency is necessary to establish neighborhood characteristics and maintain a quality streetscape. As such, the following controls are provided for the estate:

## FENCING CONTROLS

- A front fence (max 1.2, high) or landscaped hedge is to be used to define your front yard and designed to match your house facade. The front fence (if installed) is to be set 0.5m back from the property boundary with a planted strip in front.
- For side fences along a secondary facade a maximum height of 1.2m is required for the first 9m measured from the front boundary. The remaining fence may then be raised to a maximum height of 1.8m and as constructed as per Fencing Type 1. This is to allow the architectural element of the side facade to be visible and not covered by the fence.
- Feature fencing may be installed by the developer on selected lots in the development. If selected, these lots will be indicated on the release plan of each stage.

- Inter allotment fences (side and rear boundaries) are required to be timber paling fencing with a maximum height of 1.8m per Fence Type 2. For non-corner lots, inter allotment fencing is to transition from the front fence 4m past the building line.
- Side gates are required to compliment the facade of your home, this is subject to the approval of the Design Review Panel.

## RETAINING WALLS

- Any proposed retaining walls which will be visible from the street or public spaces must be set back a minimum of 0.5m from the boundary and designed to a max 0.5m in height.
- Any retaining walls retaining walls must be concrete or masonry and complement the house facade colours (unless otherwise approved by the DRP).
- All fencing and retaining walls must be completed with the construction of your home.

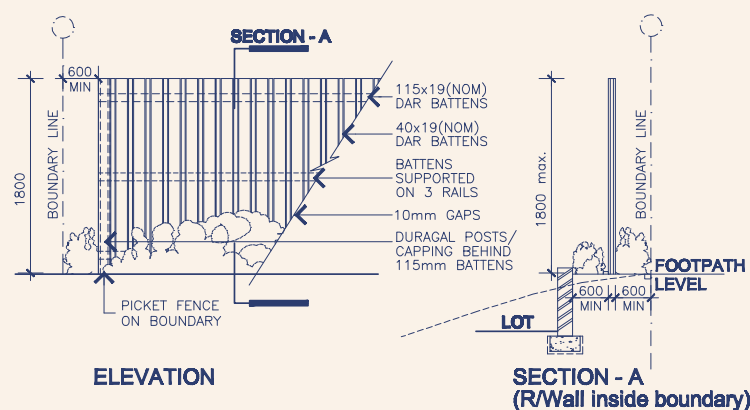

**FENCE TYPE 1 (Vertical Battens)**  
Corner lot - for rear and side fences  
(where visible from a public place)

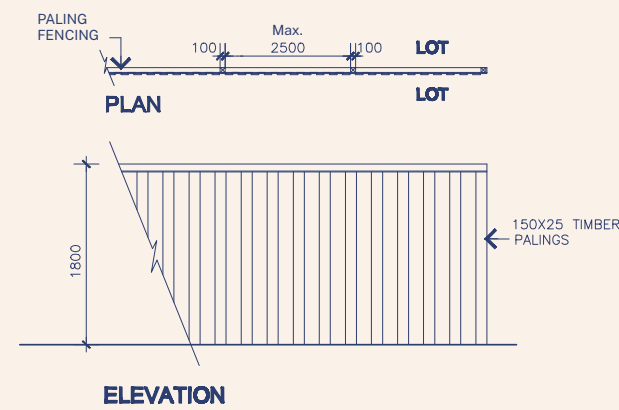

**FENCE TYPE 2 (Inter allotment fences)**

**NOTE:**  
ALL DIMENSIONS ARE IN MILLIMETRES (mm)

# 10. LANDSCAPING

## DESIGNING YOUR FRONT GARDEN

A flourishing green garden is essential to establishing your new home's overall look and feel. For this reason, all landscaped areas visible from the street or public view should be of high quality and well-maintained.

## OBJECTIVES

- To establish a visual coherence throughout the streetscapes using aesthetically pleasing landscape treatments to areas visible from a public place.
- To minimise areas of hardstand (e.g., driveways and paving) and maximise the use of soft landscape (e.g., garden beds, turf, and permeable surfaces), particularly in areas facing public open space, including streets, parks and public walkways.

- To encourage utilisation of soft landscaping (shrubs etc) to screen services such as water meters and electrical boxes.
- To provide opportunity for increased privacy.
- To encourage the use of local native and low water use planting.

## GENERAL LANDSCAPE CONTROLS

- All areas visible from the street must be landscaped (including all turf, fencing, driveways and pathways) at completion of the home.
- Landscape designs must accompany your DRP application as set out in Section 3 of the Approval Process prior to the lodgement of your development application with Council / Accredited Building Certifier.
- The Compliance Bond will not be returned by the DRP until all landscaping construction works are complete in accordance with your approved plans and have been inspected by the DRP.

- Landscaping materials and colours should complement the house façade and demonstrate a consistent landscaping theme.
- Consideration must be given to any service easements that have planting restrictions, particularly in respect of tree plantings – information is available from the relevant service authority.
- Planting of native flowering trees and shrubs is encouraged.
- Planting of shade giving trees is encouraged.
- Use of synthetic turf is not permitted.
- Avoid the use of invasive weed species. Refer to Camden Council's list of acceptable Tree Species (<https://www.camden.nsw.gov.au>).



# 11. LETTERBOXES

## CHOOSING A LETTERBOX

When designing your home, your letterbox may not be something you even consider until you have already moved in and need one! Although they may often take the back seat, letterboxes do create wonders in terms of increasing your home's street appeal. Aside from receiving and holding your mail, letterboxes help establish a first impression.

- Letterbox design is to complement and match the dwelling, using the same materials and finishes.

### DESIGN TIP Match your letterbox

*Your letterbox should match or complement your home in colour and material. For example, if your home incorporates a deeper render colour to its front entry, then you could match it to this.*

### EXAMPLE OF LETTER BOXES THAT ARE SUPPORTED:

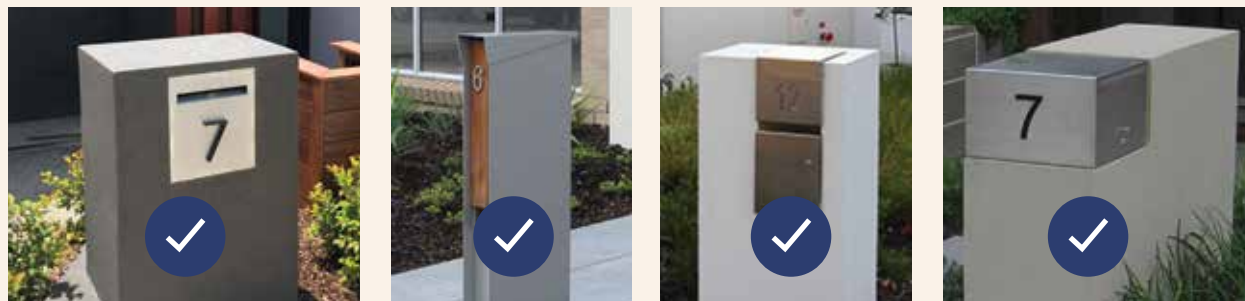

### EXAMPLE OF LETTER BOXES THAT ARE NOT SUPPORTED:



# 12. GENERAL ITEMS

## STREET AMENITY & PRIVACY

- Extensive blank walls visible from the street are not permitted.
- Windows to service rooms, such as bathrooms and laundries, should generally not be visible from the street. If these rooms are visible from the street, the use of obscure glass is required.
- Visually obtrusive and unsightly items such as hot water storage tanks, garbage bins, rainwater tanks, utility meters, air conditioning condensers, air conditioning service lines should not be directly visible from the street/public domain.
- Clotheslines, TV Antenna and garden sheds are not to be directly visible from the street/public domain. These items should also have a minimal visual impact on adjacent dwellings.
- Storage of boats, caravans or similar should not be visible from the street or public open space.
- Satellite dishes are not to be visible from the street.
- No display homes are allowed unless by Mirvac or as approved by the DRP.
- No further subdivision of allotments is permitted.
- Roof or window mounted air-conditioning units are not permitted.
- The use of solar panels within the estate is encouraged.
- An area behind the property boundary and screened from public view is required for the storage of waste bins.



\*Artist's impressions as at 21.10.22. Produced prior to all planning approvals being in place and prior to commencement of development, and is therefore subject to change. The information, images and artist's impression depicting landscaping and other amenity are intended only as a guide and are not to be relied on as a representative of the final product.



# 13. SUSTAINABILITY

Mirvac considers sustainability and innovation to be key components in delivering cohesive communities that are safe, encourage healthy and active lifestyles and result in lower household expenses. In line with Mirvac's sustainability goals, the Cobbitty by Mirvac estate will be all electric, meaning that all homes in the estate will use electricity to power all of its required energy needs.

## OBJECTIVES

- To set a new benchmark for high-quality sustainable living, and encourage the incorporation of best practice sustainable initiatives.
- To provide and encourage opportunities for residents to reduce their environmental impact.
- To provide and encourage opportunities for residents to reduce household expenses during operation.

## ENERGY CONSUMPTION AND GREENHOUSE GAS-EMISSION REDUCTION

- Mirvac encourages all homes to achieve a 7 Star NatHERS rating. This may be achieved through incorporation of the following elements where necessary —
  - Maximising opportunities for cross ventilation and provide high level operable windows in multi-level homes to allow for heat removal.
  - Shading designed to restrict solar access to the living spaces in summer, whilst allowing beneficial solar access in winter.
  - Increased rating of the wall and ceiling insulation to the required specification
  - Treated glazing or double glazing where necessary.
  - Draft sealing (weather seals on external doors etc.) where necessary.
  - Sealed exhaust fans where necessary.

- In addition to achieving a 7 Star rating on the building fabric, Mirvac encourage house designs to include the following energy saving features:
  - LED light fittings throughout the home.
  - Exterior lighting fitted with motion sensors.
  - Low energy use appliances (aim for energy ratings greater than 4 star).
  - Energy efficient air conditioning systems (aim for a COP greater than 3).
  - Standby 'Green Switch' or Smart home automation to reduce energy whilst the home is unoccupied.
  - Solar photovoltaic electricity systems with battery storage.

## WATER CONSERVATION AND REUSE

- To assist in achieving an overall reduction in household water usage, Mirvac recommends that homes incorporate the following measures:
  - Rainwater tanks for toilet flushing and irrigation.
  - Dishwasher and washing machines with a 4 Star or greater WELS rating.
  - Tapware and toilets with a 4 Star or greater WELS rating.
  - Showers with a 3 Star WELS rating.
  - Purchasers are encouraged to consider water efficient landscape design, soil mix, and plant selections, with a target of a minimum of 70% of planted species to be drought tolerant.

## SUSTAINABILITY (CONTINUED)

### MATERIALS AND WASTE

- Maximise the use of standard sizes of materials wherever possible to minimise wastage.
- Mirvac recommends the use of low-impact construction materials.
  - For masonry consider low impact options, such as recycled or carbon neutral bricks.
  - For lightweight construction, consider the use of natural or innovative materials such as timber, structural insulated panels or Hebel for a reduced environmental impact and good thermal performance qualities.
- Internal Finishes
  - Consider the use of flooring, joinery and plasterboard that is environmentally certified by independent certification schemes such as GECA, EcoSpecifier or the Carpet Institute of Australia.
  - Select high quality, durable finishes with long warranty periods.
- To reduce the airborne chemicals within your home consider the following products
  - Engineered wood products, such as kitchen cabinetry and wardrobes, with low or zero formaldehyde (rated as E1 or E0).
  - Paints, adhesives and carpets rated to have low levels of volatile organic compounds (VOCs).
- To reduce waste to landfill during the operation of your home, consider
  - Installing a dual bin in the kitchen joinery to make recycling as easy as disposing of general waste.
  - The use of a worm farm or composting bin to reduce food waste and provide fertiliser for your gardens.

### SMART TECHNOLOGY

- Smart monitoring
  - Consider the use of smart meters to help track your energy consumption and reduce your bills even further.
- Smart home automation
  - Consider the use of smart home automation to make your life easier and future proof your home. Systems available include:
    - Smart Security systems
    - Smart intercom and access controls
    - Smart controls of lighting, blinds, air conditioning and appliances
    - Audio Visual systems
- If solar electricity and/or batteries are installed, consider a fully electric house to avoid the need for a separate gas connection.

### LANDSCAPING

- The use of permeable surfaces is encouraged to maximise opportunities for natural infiltration and groundwater recharge.
- The use of waterwise plant species, waterwise irrigation and mulching of garden beds is encouraged to reduce water use.
- The planting of trees offering shade for the house and outdoor living areas and contributing to bird habitat is encouraged.
- The use of locally native plant species is encouraged to increase biodiversity.
- Consider the use of herbs, vegetables and fruit trees to create a productive garden.



# APPENDIX A

## DESIGN REVIEW PANEL APPLICATION CHECKLIST

### Cobbitty by Mirvac DRP Application Checklist

#### SITE PLAN CHECKLIST

- North Point
- Scale (1:100, 1:200)
- Lot boundaries & setback dimensions (front, rear & sides)
- Building footprint (outline)
- Finished floor level
- Existing site contours
- Location of driveway & crossover
- Location of fencing & gates
- Location of swimming pools (where applicable)
- Location of services (hot water service, water tanks, air conditioning, satellite dishes, tv antennae, clothesline, garden shed etc)
- Shadow diagram for 9am, 12pm and 3pm
- Site coverage
- Site permeability

#### SECTIONS

- Scale (1:100, 1:200)
- Existing ground level
- Finished ground level
- Cut and fill levels
- Ceiling heights
- Building heights relative to existing ground level
- Roof pitch

#### FLOOR PLAN CHECKLIST

- North point
- Scale (1:100)
- Finished floor levels
- All key internal room names
- Floor area (living, porch, balcony, alfresco, garage)
- All room and house dimensions

#### ELEVATIONS

- Scale (1:100)
- Existing ground level and finished ground level
- Materials and finishes
- Roof pitch and materials, including dimension of eaves
- Location of services (hot water service, solar panels, air conditioning, rainwater tank)

#### LANDSCAPE PLAN CHECKLIST

- Driveway materials, finish and specifications (dimensions)
- Entry path including dimensions and fence line, materials and colours
- Plant species, size, quantity and location (include imagery)

- Turf lawn extent and species
- Clothesline location
- Hot water service, rainwater tank, air conditioning unit and any screening locations
- Bin storage and screening where required (to screen bins from the street or public area)
- Fence location and type

#### DRP SUPPORTING DOCUMENTS

- Energy report
- Materials and finishes schedule (include colours and images)
- All roof colours and materials (full profile images to be provided)
- All fencing finishes and colours
- Garage door profile, imagery and colour
- Front door imagery and colour
- Retaining wall type, including finish/colour
- Fence type including finish/colour
- Letterbox location and type

# APPENDIX B

## DESIGN ASSESSMENT APPLICATION FORM

This table must be submitted with your Design Assessment Application.

Lot Number \_\_\_\_\_ Date \_\_\_\_\_

#### OWNER'S CONTACT DETAILS

Owner's Name \_\_\_\_\_ Ph. \_\_\_\_\_

Email \_\_\_\_\_

Address \_\_\_\_\_

Suburb \_\_\_\_\_ Post Code \_\_\_\_\_ State \_\_\_\_\_

The main point of contact for all design assessment correspondence will be your **builder/architect**. Please provide contact details below:

#### CONTACT DETAILS FOR BUILDER/ARCHITECT

Company \_\_\_\_\_

Main Contact Name \_\_\_\_\_ Ph. \_\_\_\_\_

Email \_\_\_\_\_

Address \_\_\_\_\_

Suburb \_\_\_\_\_ Post Code \_\_\_\_\_ State \_\_\_\_\_

By submitting this application form to Mirvac I acknowledge the following:

- My building designer is aware of the **Cobbitty by Mirvac Design Guidelines**.
- I understand that my house design must comply with all sections of the **Cobbitty by Mirvac Design Guidelines**.
- Approval by the Design Review Panel (DRP) does not guarantee my design complies with the requirements of Camden Council, Oran Park DCP, and other statutory requirements and any restrictions, positive covenants and other requirements stipulated within the Section 88b Instrument.
- My house design will need to be re-submitted for assessment under the Cobbitty by Mirvac Design Guidelines if the design changes following approval.

Signed (Owner) \_\_\_\_\_

Date \_\_\_\_\_

# APPENDIX C

## NEIGHBOURHOOD PLAN

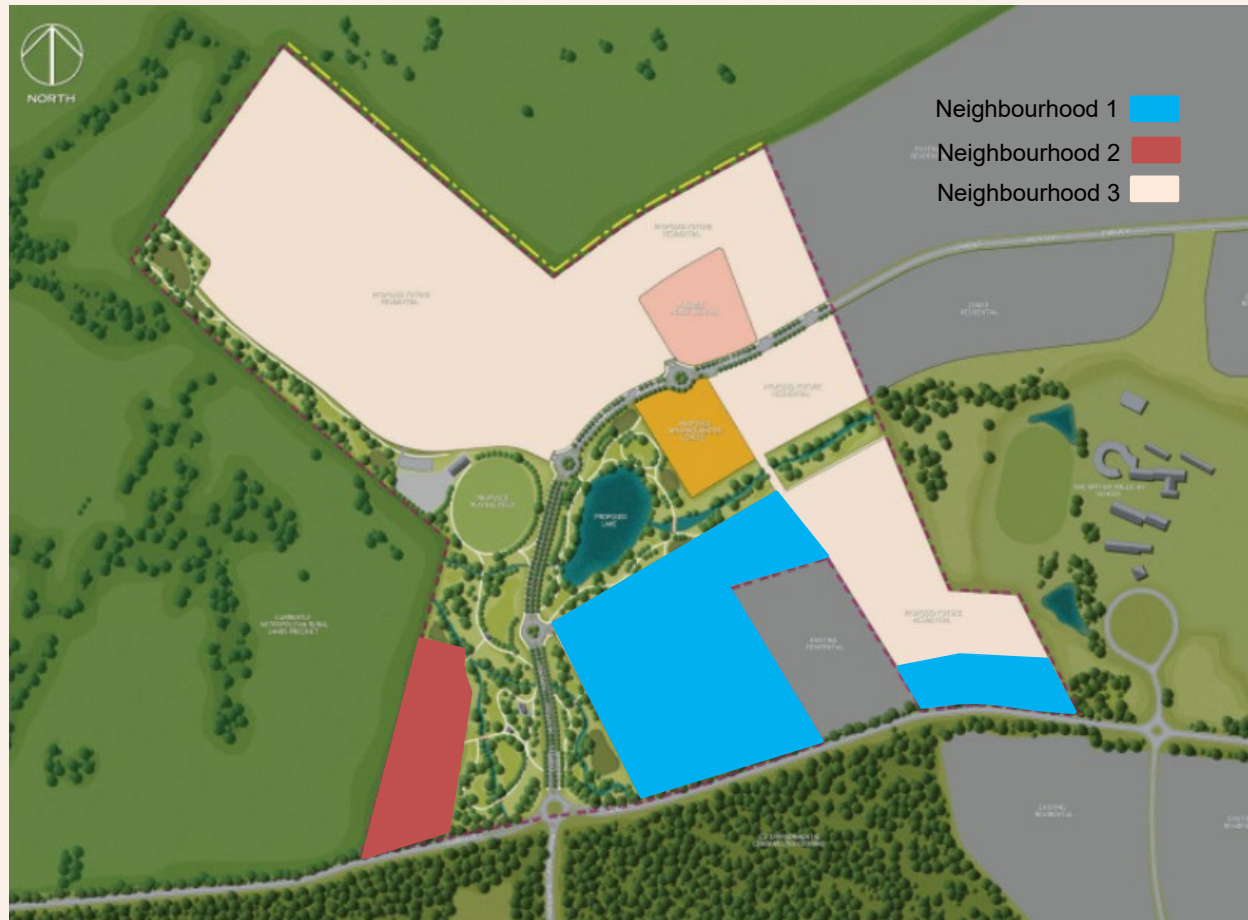



For more information regarding the design guidelines please contact:

**DESIGN REVIEW PANEL**

nswcustomer@mirvac.com  
Phone: 90808205



